

# THE INTEGRATED SAFETY/SECURITY/ COMMUNICATION SYSTEM OF THE GRAN SASSO MOUNTAIN IN ITALY

FABIO GARZIA<sup>1</sup> & ROBERTO CUSANI<sup>2</sup>

<sup>1</sup>Wessex Institute of Technology - Ashurst Lodge, Ashurst, Southampton, UK

<sup>2</sup>Department of Information, Electronics and Telecommunication Engineering,  
SAPIENZA, University of Rome, Rome, Italy

## ABSTRACT

A high safety and security level of a complex system is very difficult to be reached, guaranteed, and managed if the system is characterized by a peculiar complexity and physical extension, due to the elevate number of parameters to be checked and controlled. The use of human resources needs an elevate number of personnel members that could not only be able to reach the desired goal but could also be exposed to severe risks in the presence of dangerous and emergency situations. For this reason, it is necessary to use integrated safety/security/communication systems that are capable of managing the elevate number of parameters involved, reducing the number of personnel members, and increasing their functionalities and operability. In this paper the integrated safety/security/communication system of the Gran Sasso Mountain in Italy, characterized by a high and unique complexity from the international point of view, is illustrated. The system is also endowed with an efficient early warning system capable of predicting in advance, with an error equal to zero, any critical situations, allowing the activation of the relative procedures to avoid critical and dangerous situation.

*Keywords:* Control system, early warning system, integrated safety/security system, supervision system, telecommunication system.

## 1 INTRODUCTION

The Gran Sasso ('big rock') mountain is located in the center of Italy, about 120 km east of Rome, between the L'Aquila city province and Teramo city province, in the Abruzzo region.

It belongs to a system of mountains that practically separates the Adriatic Sea (east) from Tirrenian Sea (west) in the middle of Italy.

The higher peak of Gran Sasso Mountain is represented by Corno Grande ('big horn'), which is about 3,000 m above the sea level.

Due to the elevate altitude, even if the mountain is not so far from the Adriatic Sea, a permanent glacier is also present.

On the high plane of Gran Sasso Mountain, named Campo Imperatore ('Emperor high plane'), a sky resort is also present.

Under the Gran Sasso Mountain, there is a separate double highway tunnel (one tunnel for traffic in the L'Aquila – Teramo direction and one tunnel in the Teramo – L'Aquila direction). These tunnels take the traffic from the west to the east side of central Italy and vice versa, and they represent a vital connection for road traffic. The length of tunnel is about 10 km, representing the second longest road tunnel of Italy, in term of length, after the Monte Bianco ('white mountain'), that is anyway one of the longest road tunnel at the international level (even if single tunnel, while the Gran Sasso is a double tunnel).

A partial view of the Gran Sasso Mountain from L'Aquila side is shown in Fig. 1.

Inside the mountain, the underground Gran Sasso Mountain National Laboratories (GSNL) of Italian Institute of Nuclear Physics (INFN) are also present. They are located 1,400 m under the central rocky mass, named Eagle Mountain.

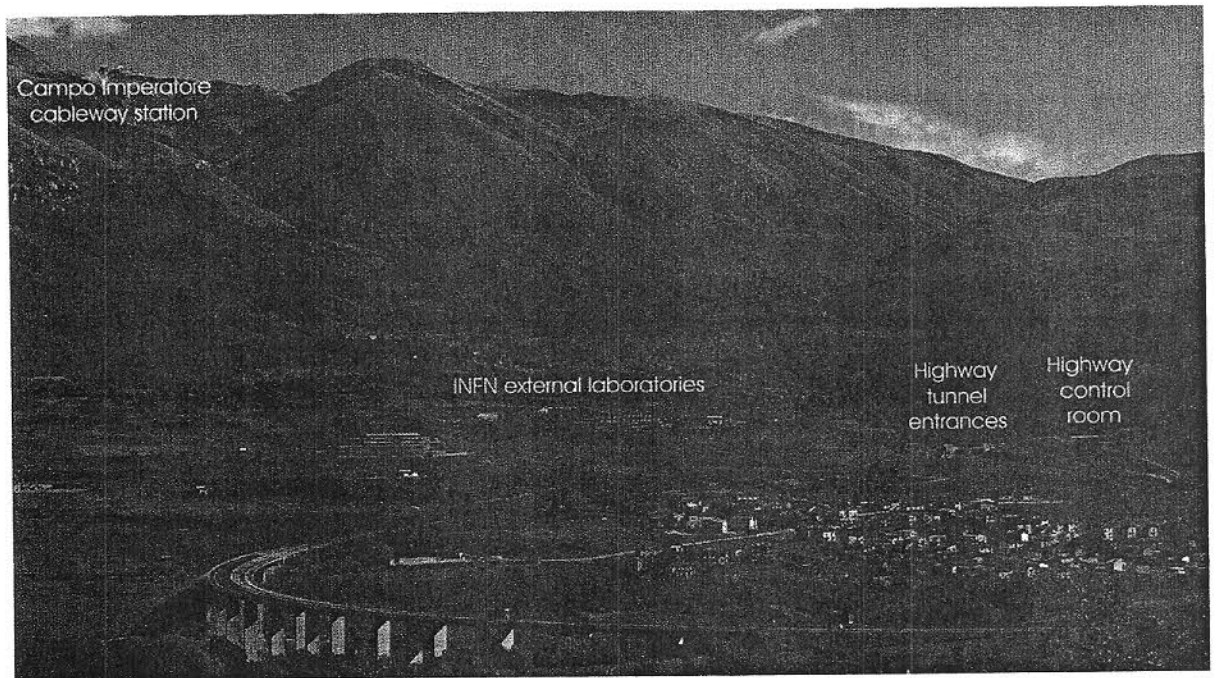

Figure 1: Partial view of Gran Sasso Mountain from L'Aquila side.

The offices and the directional center are located 1 km away from the Assergi highway exit (in the L'Aquila city province) and they extend on a 12,000 m<sup>2</sup> surface, while some technical installations (fanning, electrical supply, etc.) are located on the other side of Gran Sasso Mountain (in the Teramo city province) just outside the highway tunnel, in a site named Casale S. Nicola.

The entrance of GSNL is located in the Teramo – L'Aquila direction tunnel using a passage reserved to the laboratory traffic and created by means of a narrowing of about 1 km of the tunnel road in the correspondence of underground laboratories.

The GSNL are the biggest and most important underground laboratories of the world characterized by a unique environment for the kind of research undertaken inside. Further, they have been realized on purpose and have not been recovered or adapted already existing structures, such as active or closed mine (KAMIOKANDE in Japan and SNO in Canada).

The design, the approval, and the public financing have been possible to the simultaneous drilling and construction, in 1970–1980, of the highway tunnels in the same zone. The GSNL realization started in 1982 and the construction of the first experimental apparatus started only 4 years later, in 1986, when the first tunnel was opened to the public traffic. The underground laboratories are mainly constituted by three experimental rooms, whose dimensions are about 100 × 20 × 20 m, and by a series of connection tunnels that are used for the installations necessary for the correct functioning of the laboratories and for hosting secondary and reduced dimension experimental devices. The total internal volume is about 180,000 m<sup>3</sup>. A 3D view of laboratories is shown in Fig. 2.

GSNL represent the ideal environment for experiments concerning neutrinos, since the large amount of rock above them shields most of the nuclear particles coming from the sun and from the cosmos and let pass only the neutrinos that tend to interact very rarely with matter.

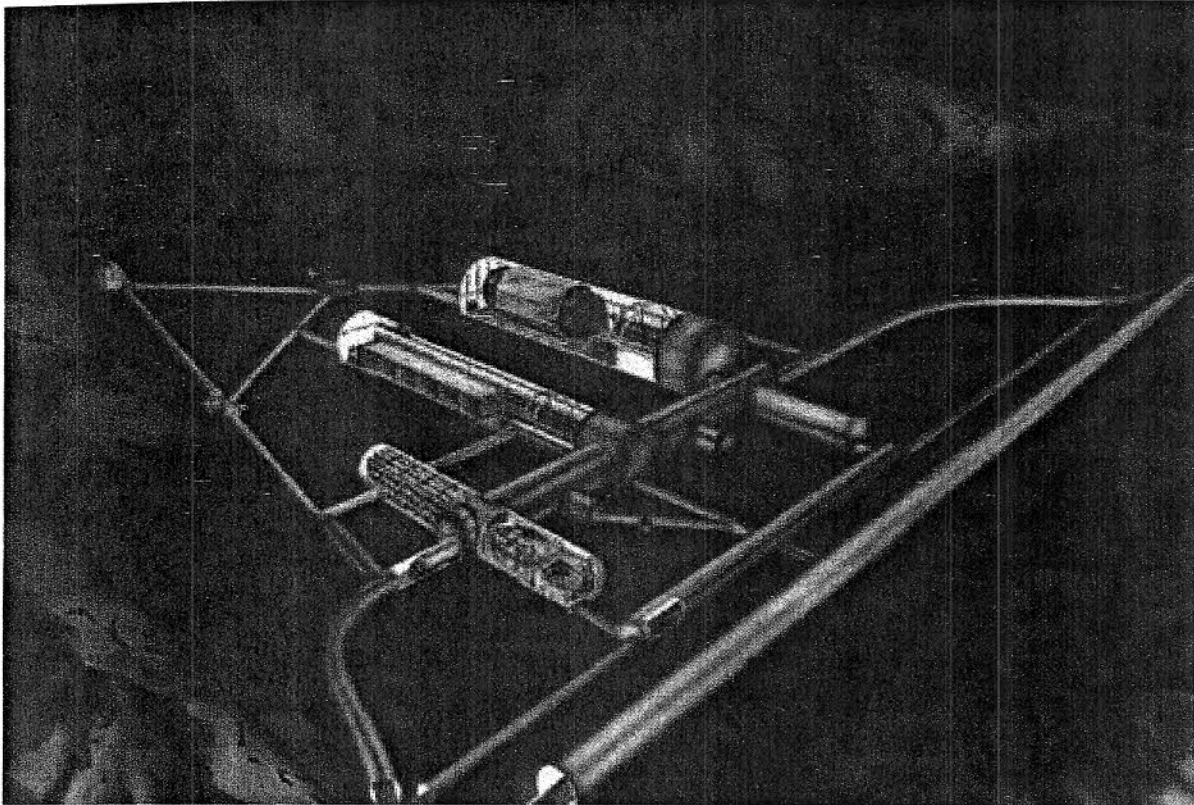

Figure 2: Three-dimensional view of the laboratories and part of highway tunnels.

Actually there are 18 experiments working in the three experimental rooms and in some connection tunnels, namely: Borexino, COBRA, Cresst, Cuore, Dama, Libra, ERMES, GERDA, Gigs, ICARUS, Luna, LVD, OPERA, Pulex2, Tellus, Underseis, VIP, WARP R&D, and XENON.

The research in the GSNL is strictly connected to the CERN (French acronym of Centre Européen pour la Recherche Nucléaire that means European Centre for Nuclear Research) of Geneva in Switzerland where there is a neutrinos generator that shoots a neutrinos beam toward GSNL, travelling for 730 km underground.

Recently OPERA experiment seems to indicate that the neutrinos coming from CERN travel at a velocity 20 parts per million above the speed of light, nature's cosmic speed limit. Given the potential far-reaching consequences of such a result, independent measurements are needed before the effect can either be refuted or firmly established. This is why the OPERA collaboration has decided to open the result to broader scrutiny.

It is evident that a lot of subjects are present in the Gran Sasso Mountain that make specific activities (INFN laboratories, highway, aqueduct, etc.), and for this reason the Gran Sasso Mountain represents a wide and complex system where each component interacts, unavoidably, with the other components. In fact, for example, the highway represents the only entrance to the laboratories where not only people but also all the installations (such as electrical, fanning, cooling, telecommunications, etc.) that guarantee the correct functioning and the safety of laboratories must pass through. This implies that a possible accident inside the highway tunnels can compromise not only the stability and reliability of the installation of the laboratories but also the capability for fire brigades, highway tunnel personnel, and emergency

teams of reaching the laboratories. The same happens if an accident takes place inside the laboratories. For this reason, the emergency plans related to one of the subjects, which operates inside the Gran Sasso Mountain, must consider also the other present subjects.

This characteristic gives the Gran Sasso Mountain an extreme oneness at the international level.

The plant of highway tunnels with INFN laboratories is shown in Fig. 3.

Due to the multitude of people, systems, devices, and installations that must be controlled and that must communicate each other, it is evident that the Gran Sasso Mountain, must be managed securely in the best way and needs to use intensively advanced technologies finalized to obtain a high and efficient quality of functionality, performances, and services [1–9].

To increase the safety and security level of people who operate in Gran Sasso and to protect the unique natural environment, in July 2003 the Italian Government, through the Department of Civil Protection, designated a Delegate Commissioner of Government.

The integrated safety/security system presented in this paper was studied and designed by the authors during their activity of consultant of Delegate Commissioner of Government, concerning the safety and security aspects of Gran Sasso. The transversal schematization of the Gran Sasso Mountain is shown in Fig. 4.

Due to the complexity of Gran Sasso Mountain and of the subjects that operate in it, the mentioned system represents a unique object at the international level in term of functionalities and reliability, greatly increasing the safety and security of the people and of the surrounding environment.



Figure 3: Plant of highway tunnels with INFN laboratories (in the middle, upper side). L'Aquila city direction is on the left side, while Teramo direction is on the right side. Tunnels are about 10 km long.

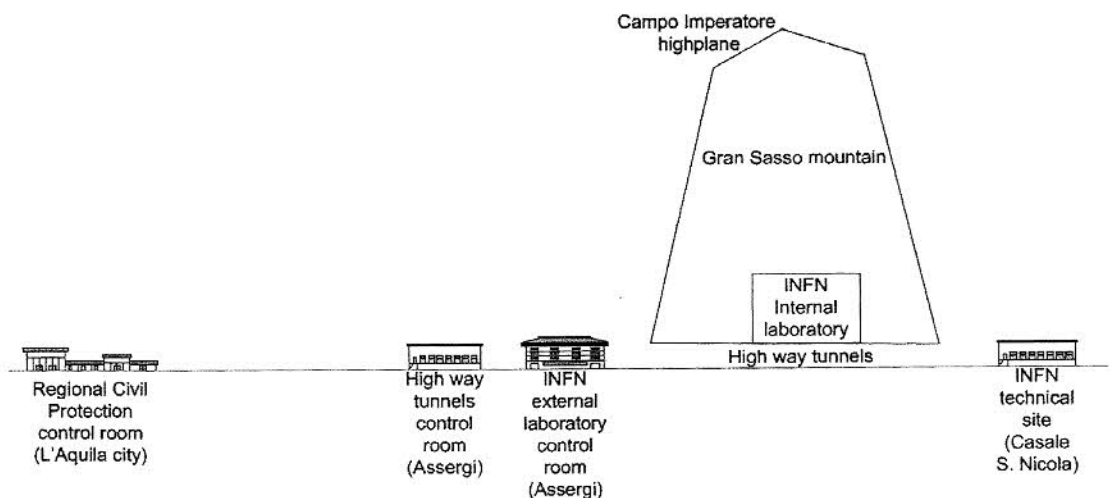

Figure 4: Transversal schematization of Gran Sasso Mountain system.

The scope of the paper is to illustrate the above mentioned advanced system, the difficulties found for its design and the results obtained.

## 2 THE INTEGRATED SAFETY/SECURITY/COMMUNICATION SYSTEM

The designed system is aimed at improving safety, security, communication, and emergency management in a totally automatic and immediate way or at aiding the personnel by means of an expertise information system, allowing the control and activation of any component present in Gran Sasso and connected to the integrated system, by means of local or remote consoles.

The system not only aimed at integrally control safety, security, communication, and emergency but also aimed at providing a series of advanced services (such as an innovative radio communication system) to the whole community that operates inside it or on it or lives in the surroundings.

The considered integrated system allows the maximum integration and communication of all the installations, devices, and systems present in the Gran Sasso, both inside or outside, and it guarantees their control and management in a totally automated way, according to predefined procedures.

The system includes an advanced radio communication and localization system, capable of operating both inside and outside Gran Sasso Mountain, covering a wide area that extends from L'Aquila city to Teramo city and passing above it through Campo Imperatore high plane. This radio communication system, extremely innovative, is capable of ensuring an instantaneous link between all the subjects involved in safety, security, and emergency situations and can be used, in ordinary conditions, from all the enabled subjects that operates inside, outside, or in the surroundings of Gran Sasso Mountain.

The system integrates the following components present in Gran Sasso Mountain:

1. GSNL laboratories:
  - a. radio communication and localization of safety, security, and emergency personnel;
  - b. wireless communication, localization, and advanced information service of personnel;
  - c. video surveillance TV (internal and external);
  - d. access control;
  - e. anti-intrusion;
  - f. public address;
  - g. video information service;
  - h. internal parking management system;
  - i. interface with incidental lost liquid monitoring system, water source quality monitoring, fanning system, cooling system, experimental devices operating in the laboratories, electrical supply installations, fire and dangerous gas monitoring systems, environmental monitoring systems;
  
2. Highway tunnels:
  - a. radio communication and localization of safety, security, and emergency personnel;
  - b. predisposition for cellular phone communication system installation;
  - c. video surveillance TV;
  - d. optical fiber fire sensor;
  - e. interface with technical installations, traffic management system, environmental monitoring systems;

3. External:

- a. radio communication and localization of safety, security, and emergency personnel;
- b. interface with various systems and installations, environmental monitoring systems.

The system guarantees a high degree of integration between the GSNL subsystem, the highway tunnels subsystem, and the external subsystem, ensuring a correct and immediate control of all data and significant events for safety, security, and emergency of Gran Sasso Mountain.

In this way, a system has been designed whose functionalities are really superior with respect to the functionalities of single subsystems, devices, installations, or elements.

The system operates due to an advanced telecommunication subsystem, characterized by a high reliability that is capable of working in the presence of the severe climate conditions present inside and outside the mountain. The telecommunication subsystem is described later.

The designed system is characterized by a high degree of modularity and expandability so that it is possible, in future, to add and integrate any other installation, device, or apparatus in any point, inside or outside the Gran Sasso Mountain, guaranteeing always the full control of any components present in GSNL, highway tunnels, or anywhere.

The integrated system concentrates the alarm signaling generated by the various installations and devices in four control rooms, unifying the management procedures and optimizing the needs of personnel resources necessary for organization and maintenance.

The four control rooms are

1. internal GSNL;
2. external GSNL;
3. external high way tunnels;
4. regional Civil Protection (L'Aquila city).

4 The system is extremely modular and flexible and allows addition of, at any time, other control rooms or management consoles, according to specific needs that could appear in future.

The control room of regional Civil Protection is designed to transmit, in normal or emergency situations, data or alarm signaling to other subjects, such as

1. National Civil Protection;
2. fire brigades;
3. police;
4. aqueducts management societies;
5. national park guard;
6. regional water authority;
7. Abruzzo regional administration;
8. L'Aquila provincial administration;
9. Teramo provincial administration;
10. L'Aquila prefecture
11. Teramo prefecture;
12. local town administrations;

and any other subjects that could be individuated in a second time and located even at great distance from Gran Sasso Mountain.

The functional block diagram of the integrated system is shown in Fig. 5.

The correct integration of installations and devices is reached coordinating the design of installations with the operative needs of laboratories and highway tunnels, from one side, and improving the use of each technological component to better use their functional features, from the other side.

The video surveillance is therefore used, for example, to view the zone where there is an alarm signaling, restricting the physical movement of safety and security personnel only to

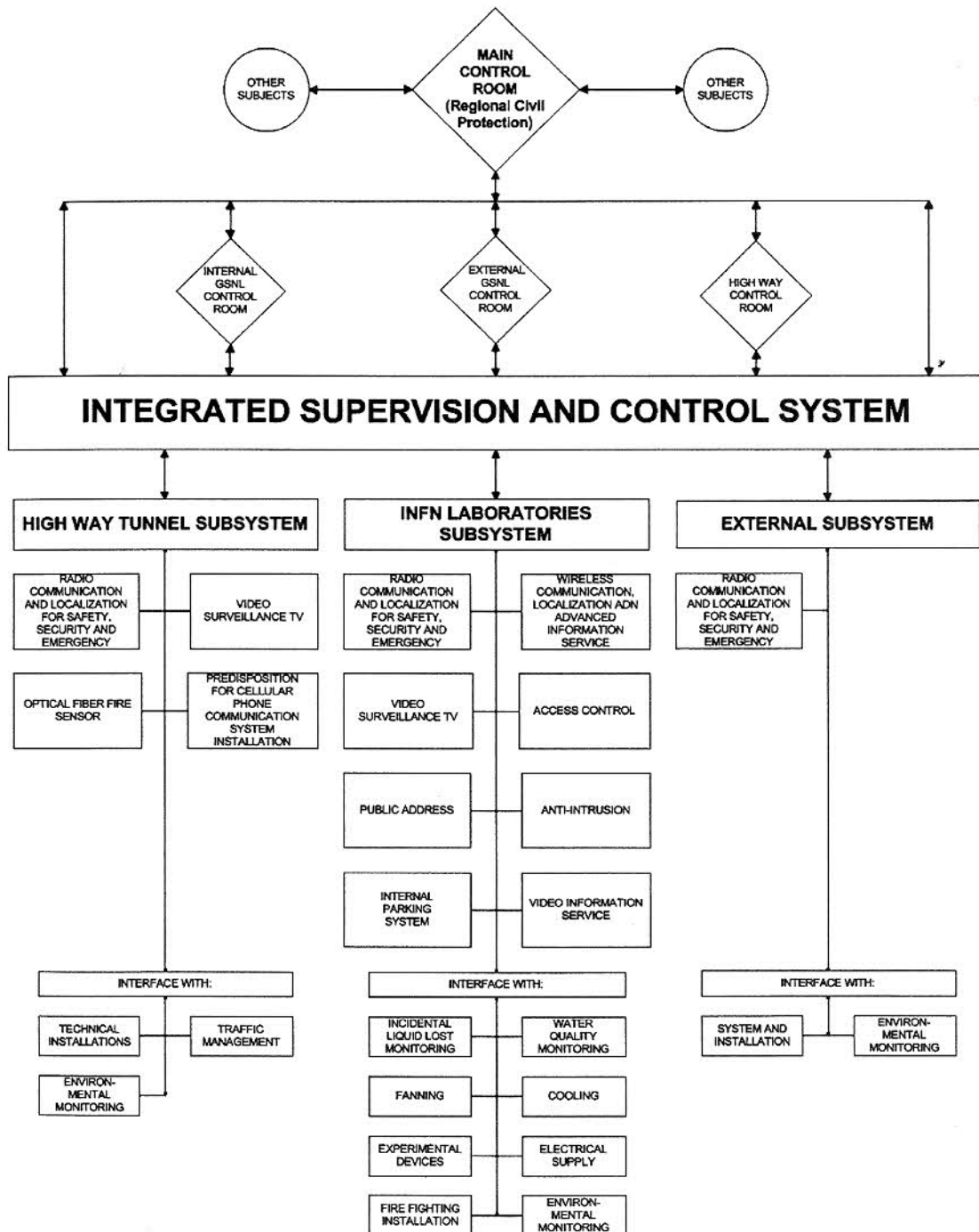

Figure 5: Functional blocks diagram of the integrated system.

the real needs, increasing their efficiency and at the same time their safety, keeping them far away from dangerous situations.

The supervision system works according to proper manuals of procedures agreed with Civil Protection, interested Prefectures, Laboratories, highway society, and all the other interested subjects.

The consoles located in the different control rooms can manage, according to the needs and the assigned operative level, every component of the system, acting only as display units or as operative activation units. These consoles can be located even at a great distance from Gran Sasso, thanks to the transmitting capabilities owned by the telecommunication subsystem.

The system also allows the enabled radio units (radio communications or wireless) to operate as mobile consoles.

### 3 DESIGN CRITERIA OF THE SYSTEM

The system was designed according to high reliability standards, since it must work in any severe conditions.

The system is divided into autonomous subsystems for two main reasons:

1. in case of malfunctioning of any subsystem, the other subsystems can continue to operate, ensuring their functionalities; and
2. due to its dimension and physical extension, its integral realization takes certain time. In this way, it is possible to realize each single subsystem that can immediately operate independently from the other subsystems.

Any subsystem is characterized by a high reliability, being supplied from different electrical sources, properly backed-up, that allow them to operate even in the absence of the main electrical supply for a long time.

Any component of the system is constantly and automatically checked and monitored from the functionality point of view so that any malfunctioning is immediately individuated: in this case, the necessary alarm signaling is sent to the maintenance personnel to activate the repairing procedures.

The system can anyway operate even with reduced performances, with one or more than one damaged components, due to the severe operative conditions such as the one imposed by the climate conditions and from possible severe accident (e.g. a car accident, with consequent fire, in the highway tunnels).

The main subsystems are

1. the INFN laboratories subsystem;
2. the highway tunnel subsystem; and
3. the external subsystem.

According to this division, even the functional subsystems (i.e. main telecommunication subsystem; radio communication and localization of safety, security and emergency personnel – TETRA system, etc.) are divided to serve, separately and independently, the three subsystems, conserving their unity.

The system was designed to reduce, as more as possible, the environmental impact, providing its advanced functionalities without any interference with the Gran Sasso environment, from any point of view.

#### 4 THE TELECOMMUNICATION SUBSYSTEM

The design of the telecommunication subsystem started with the analysis of data flows that must be carried out by the system with a high velocity, reliability, and security [4–8].

The telecommunication subsystem is capable of operating, with high performances, in the severe climate conditions present inside or outside Gran Sasso Mountain, ensuring a high security level of data that flow inside it.

The telecommunication system is composed by four subsystems:

1. Main telecommunication subsystem;
2. radio communication and localization of safety, security, and emergency personnel;
3. wireless communication, localization, and advanced information service of personnel; and
4. predisposition for cellular phone communication system installation in the highway tunnels.

The main telecommunication subsystem is composed of a fixed infrastructure that is totally redundant to increase the reliability of the whole system. It is capable of auto-reconfiguration in case of damage of part of it due to incidental events. It represents the telecommunication backbone of the whole system, allowing the communication between any element connected to the system and with the control rooms.

The fixed infrastructure, since it extends even in the highway tunnels, is characterized by a loop architecture whose branches extend in the different tunnels. In this way, in the presence of a heavy road accident inside one tunnel that could damage a part of the tunnel itself and the related installations, the telecommunications are ensured through the other branch of the loop that extends inside the other tunnel.

The scheme of the fixed telecommunication subsystem is shown in Fig. 6.

To increase the reliability of the fixed infrastructure, two different fixed infrastructures are used: one for INFN laboratories subsystem and one for highway tunnel subsystem. The two infrastructures use a loop architecture that is installed in different zones of the tunnels: in this way, an incidental event that should damage a part of one loop cannot damage the other loop.

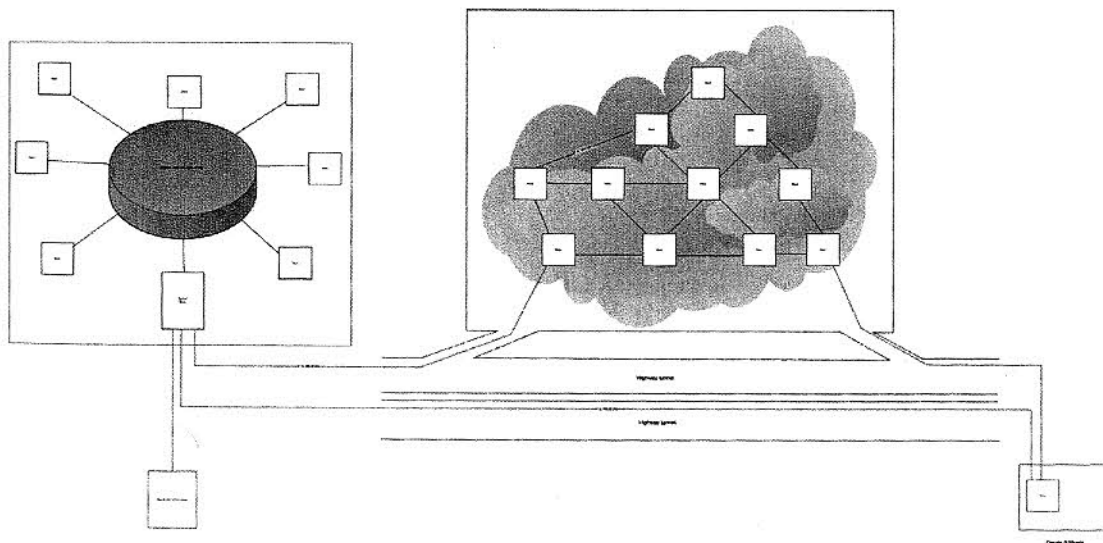

Figure 6: Scheme of the fixed telecommunication subsystem.

To guarantee the maximum level of reliability, the main telecommunication subsystem uses microwave repeaters: this way always guarantees two redundant channels (ground channel and air channel) to ensure the communications to reach the final destination. A microwave repeater is installed on the already existing pylon on Campo Imperatore, to connect the control rooms of INFN laboratories (external), highway tunnel and Civil Protection in L'Aquila city (about 15 km away), all located on the L'Aquila province side of Gran Sasso. Another microwave repeater is installed on an already existing pylon located in the technical zone of Casale S. Nicola of INFN laboratories to connect the Teramo province side of Gran Sasso with the other side and with the top of Prati di Tivo, where a radio base station is present (that is illustrated later), ensuring radio coverage until Teramo city.

The radio communication and localization of safety, security, and emergency personnel is designed to allow a prompt diffusion of information and a rapid response of personnel involved in any emergency situation. It is strongly integrated with the other components of the telecommunication system.

Due to the variety of performance requested, a collective access radio system has been designed. It is capable of satisfying all the communication needs of the Gran Sasso subjects. The mobile system is composed by a series of base stations (such as ordinary GSM or UMTS mobile communication system) connected to a central unit that manages and controls the service of radio units of the users.

In a collective access radio system the frequency are dynamically assigned to the users, according to the their needs, allowing an efficient and dynamic management of the system.

The radio communication system allows the interconnection with the internal and the external telephone net, guaranteeing a high level of connectivity.

The used digital technology shows the following advantages:

1. better quality of vocal messages;
2. higher transmission and receiving velocity;
3. lower dependence from signal receiving level;
4. higher security of conversation due to the used cryptographic algorithm; and
5. capability of using the mobile units not only as phones but also as data terminals to transmit and receive any kind of information.

Every used radio link can be divided into four different channels, that are used singularly or together as a function of the necessary transmission band.

The mobile system checks continuously the coding/decoding quality of the voice, allowing an optimal communication service even in the presence of noise.

The system allows a multi-level user authentication (user – mobile system; mobile system – fixed net; network – network; user – user), using high security cryptographic algorithms. It also supports a multi-traffic profile, which allows voice and data service with the same terminal at the same time. The voice traffic is based on a Time Division Multiplexing Access (TDMA) transmission technology, while the data traffic is based on a Packet Data Optimized (PDO) transmission technology. The used PDO technology also allows a full compatibility with TCP/IP protocol and all the related facilities.

Further, the mobile system is characterized by a high security level through

1. the use of mutual authentication (radio unit – base station and vice versa);
2. cryptographic communications using both static and dynamic keys;
3. support of end-to-end cryptographic communications;

4. disabling capabilities of stolen or lost radio units; and
5. management of data directly through IP network using ciphered protocol.

The radio communication system offers the following vocal services:

1. Individual call: this service is equivalent to the communication through a cellular phone (i.e. a user calls another user);
2. Group call: a user calls a defined group. Every member of the group can listen and talk to everybody. The group is defined in a flexible way, that is, each user can be added to the group or deleted from the group at any time;
3. Direct call: two or more radio units communicate directly without the support of the base station;
4. Broadcast call: a unidirectional point-multipoint call in a certain zone. The zone and the users can be dynamically defined;
5. Emergency call: allows to make a high priority call pressing an emergency button on the radio unit;
6. Include call: allows of calling or inserting in a call one or more supplementary users;
7. Open channel: a group of users can talk on a certain radio channel and all the users can listen and talk at any time.

The radio communication system also offers data services.

The scheme of the radio communication system is shown in Fig. 7.

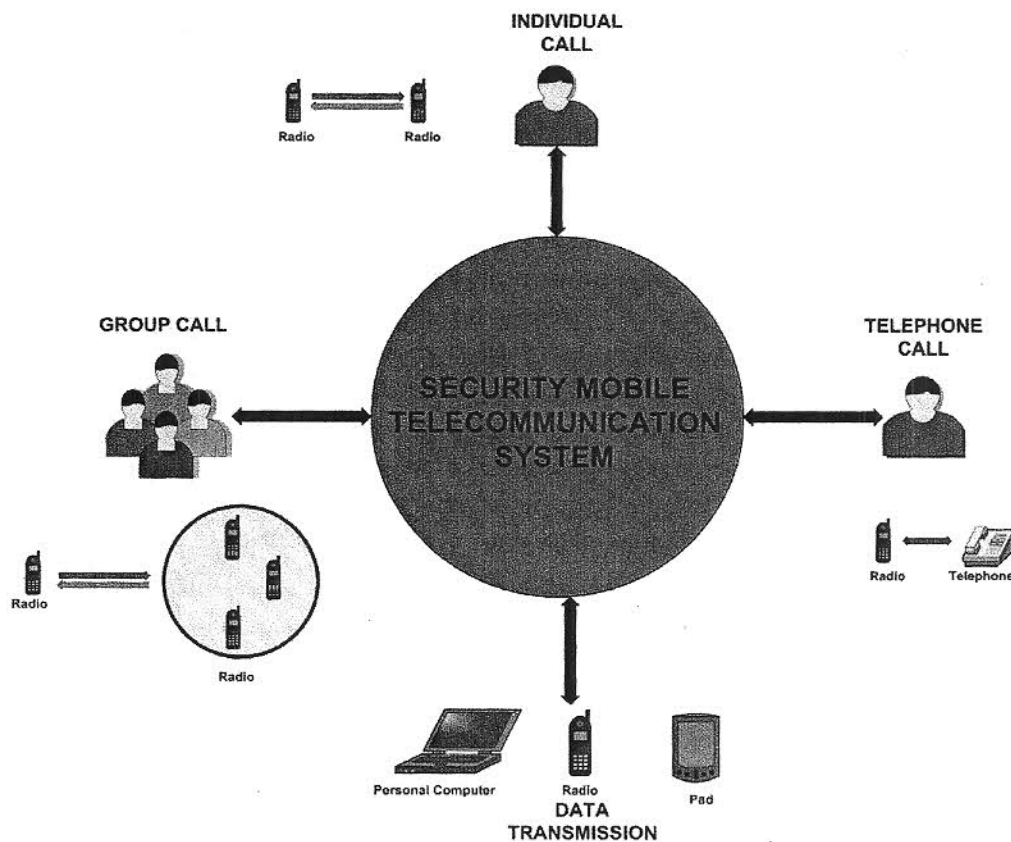

Figure 7: Scheme of the radio communication subsystem.

It is composed of a control center, called master site (MS) and a variable number of base stations (BS) positioned on the territory. The emitted power is reduced, as more as possible, to guarantee a high quality of service and a reduced emission of electromagnetic fields. The BSs are located on Campo Imperatore and INFN external laboratory, to ensure the service on the L'Aquila Gran Sasso side; BSs are located on INFN Casale S. Nicola technical site and Prati di Tivo, to ensure the service on Teramo province Gran Sasso side. Some micro BSs are present inside highway tunnels and underground laboratories to distribute the low level electromagnetic field by means of a proper radiating cable to ensure a full coverage of the Gran Sasso interior.

The designed radio communication system allows, using a common infrastructure, a lot of users to communicate without reciprocal interference and with a high reliability, being promptly localized for safety, security, and emergency purpose.

The scheme of the internal radio communication subsystem is shown in Fig. 8.

The territorial distribution of the base stations represents a typical optimization problem that has been solved using genetic algorithms [8].

Once the distribution of the base station outside the Gran Sasso Mountain is optimized, a proper radio coverage has been obtained that extends all over the mountain, starting from L'Aquila city and reaching Teramo city, where generally the emergency personnel leaves to reach the Gran Sasso mountain in case of emergency. In this way, the emergency personnel is capable of communicating directly from these two cities with the personnel who is inside or outside the mountain. The coverage of the radio communication system outside the Gran Sasso Mountain is shown in Fig. 9.

The positioning of the communication devices outside the Gran Sasso Mountain is shown in Fig. 10.

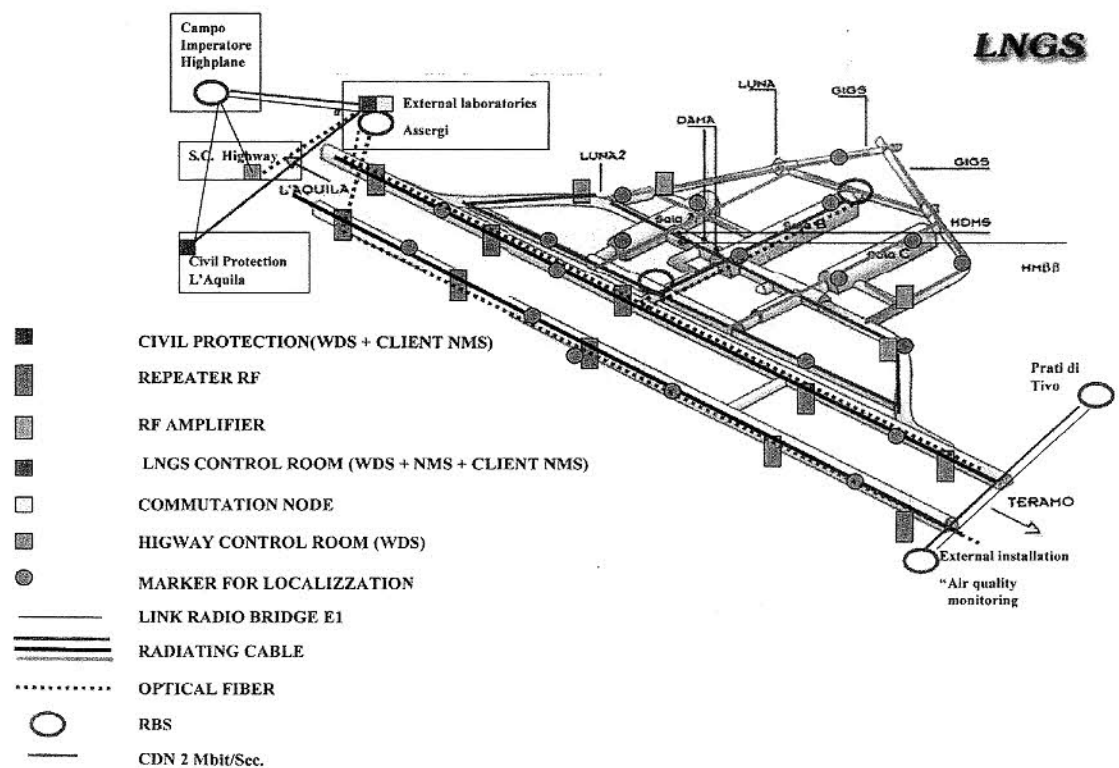

Figure 8: Scheme of the internal radio communication subsystem.

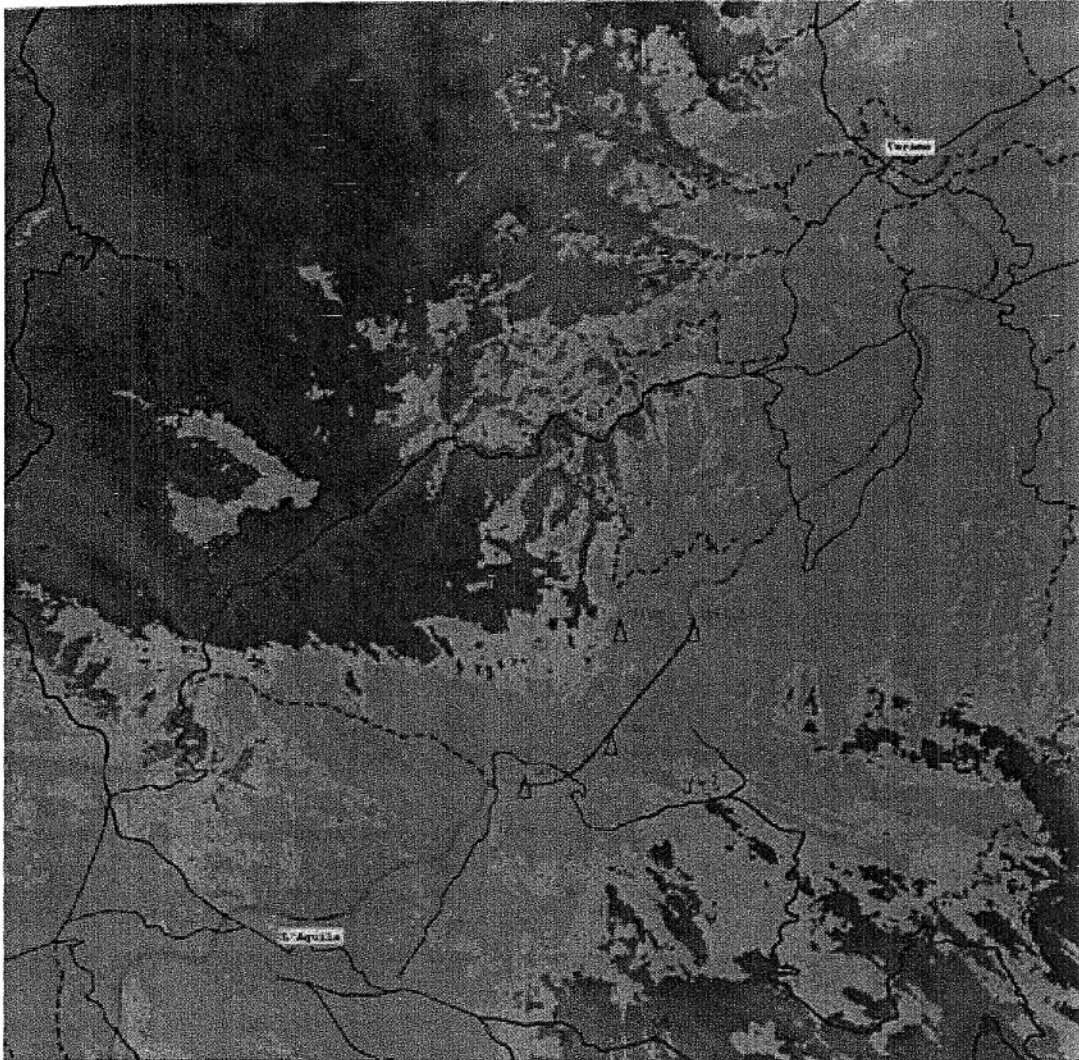

Figure 9: Coverage of the radio communication system outside the Gran Sasso Mountain.

Another communication subsystem is represented by the wireless network. This system uses light portable terminals carried by any person that goes to the underground laboratories. This system uses a wireless LAN, distributed all over the internal and external laboratories, which allows localization of all the people and any kind of communication (voice, external and internal phone, video, data, etc.). The wireless system allows the implementation of advanced services, including the capability of controlling, if the user is enabled, specific components of the integrated system or the capability of receiving alarm signaling by it.

To increase the safety level of people inside the laboratory, in case of malfunctioning of a wireless terminal, the use of reduced weight wireless identification device (WID) that send a signal to the wireless LAN periodically is planned. The wireless system is therefore able to localize the owner of WID in a totally autonomous way with respect to the wireless terminal. In this way, it is always possible to localize, with high precision, with all people inside the laboratories, which is an important feature in case of emergency evacuation. The wireless network is quite critical and, to reach its advanced performance, it has been designed on purpose using genetic algorithms 10.

The last telecommunication subsystem is represented by the cellular phone in the highway tunnels (only predisposition for installation is designed, since the operative frequencies are

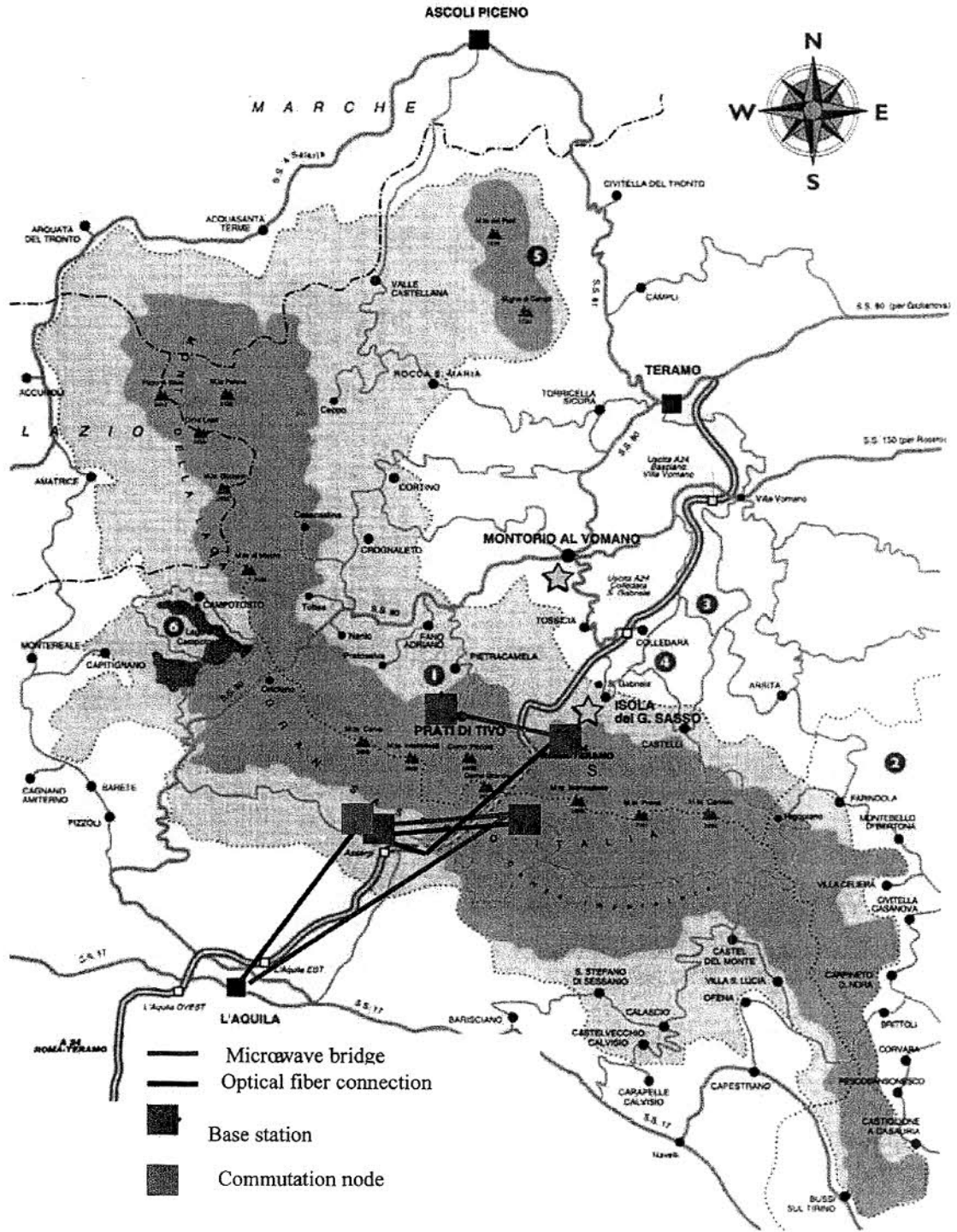

Figure 10: Positioning of the communication devices outside the Gran Sasso Mountain.

already assigned to private cellular companies that can now easily install their systems inside tunnel). It allows significant services, such as public communication of car drives, which is a very important in normal and emergency conditions.

The system is complementary to the wireless service, since the wireless terminals are also endowed with cellular phone capabilities. In this way, the personnel directed to the laboratories can fully utilize wireless service using the cellular net.

The cellular net uses the same radiating wire used by the other radio communication systems to reduce, as more as possible, the installation of wires in the highway tunnels. It is also characterized by a reduced emission of electromagnetic fields, since the power is gradually released along the cable and not emitted by means of antennas.

The telecommunication system has been designed to be capable of using satellite connections so that it is possible to ensure its services, even with a reduced velocity due to satellite link limitations, all over the world.

## 5 THE EARLY WARNING SYSTEM BASED ON NEURAL NETWORKS

Due to the multitude of parameters of system that is necessary to control and that enter the integrated system, an early warning system based on neural networks has been designed. The system is capable of learning and analyzing all the critical situations that are going to generate inside and outside the Gran Sasso Mountain and to alert immediately the safety/security/emergency personnel when a proper combination of these parameters reaches an alert condition, allowing a rapid activation of the related procedures and avoiding the creation of dangerous situation for people and infrastructures.

Neural networks actually find a lot of applications in different fields, such as

1. Electronics: process control, machine vision, voice synthesis, linear and nonlinear modeling, signal analysis;
2. Robotics: trajectory control, vision systems, movement controller;
3. Telecommunications: image and data compression, noise reduction,
4. Security: face recognition, voice recognition and other biometrics applications, new sensors;
5. Defense: weapon steering, signal and image identification, radar and image signal processing, object discrimination and recognition;

and other fields, such as aerospace, insurance, banking, manufacturing, automotive, medical, financial, and entertainment.

The common element of their field of applications is the need of classifying a given element as belonging to one or more given classes.

One of the main referring model for the reproduction of human intelligence is the so-called 'Connectionism' that postulates the logic equivalence between any structured knowledge and a proper neural network. The Connectionism allows the development of a new form of artificial intelligence based on a sub-symbolic computation instead of the symbolic computation that represents the typical application field of the classical artificial intelligence. Connectionism originates from the study of the working mechanisms of the central nervous system of biological organisms.

Human brain is composed of neurons that are cells whose purpose is represented by the information processing. Each neuron is connected with the other by means of a central body called axon and by numerous terminations called dendrites. The connection points between neurons are called synapses that show an excitatory behavior if they allow the electrical pulses to pass or an inhibitory behavior if they stop these pulses.

Each neuron behaves as an adder of the pulses generated by nearby neurons: if the sum overcomes a certain threshold, the neuron activates let the information to proceed along its path.

The connections between neurons can be modified allowing the memory effect to take place.

Artificial neural networks imitate this mechanism generating a knowledge database by means of the modification of the connections of a net that can learn from direct experience modifying its internal state to adapt to the solution of a particular problem.

The modeling of the behavior of neural networks is quite complex and generally uses the approach of the dynamic systems and the related concepts, such as cycles, strange attractors, and equilibrium points.

Neural networks are particularly useful when the law related to a certain phenomenon is not known in a deterministic way but it is necessary to reproduce it.

Neural networks are very useful when

1. it is necessary to generalize the knowledge acquired on a restricted base to a wider base;
2. a certain situation changes with time;
3. data are not complete, uncertain, or influenced by errors;
4. it is necessary for tolerance to troubles or malfunctions;
5. it is necessary to find rapidly a heuristic solution to a particular problem;
6. a phenomenon rapidly changes and short adapting times are requested;
7. a high computational parallelism is requested;
8. a proper algorithm is not known;
9. qualitative or incomplete data are present;
10. the problem is data intensive instead of number crunching; and
12. (11) it is necessary to produce a knowledge for an expert system.

For all these reasons, neural networks represent a useful and flexible tool for a lot of situations.

### 5.1 Neural networks modeling

The elementary computation element of this kind of technology is represented by the neuron that is a cell that receives one or more input values and produces one or more outputs that depend on the input values, as shown in Fig. 11.

Considering a single input – single output neuron, if  $p$  is the input and the  $w$  the weight, the product  $wp$  reaches the  $\Sigma$  unit where it is summed to a bias value  $b$ , that can be considered as an input of value equal to 1 and whose weight is equal to  $b$ . The computed quantity  $n = wp + b$  reaches the transfer function  $f$  that calculates the output of the neuron  $a = f(wp + b)$ .

The parameter  $w$ ,  $p$ , and  $b$  are adjustable and they can be adapted so that the neuron exhibits an interesting or desired behavior.

Therefore, an elementary neuronal cell performs simple operations, such as additions and multiplications, which can be easily executed by low computation capabilities devices. Their strength relies on their organization in massively parallel architectures.

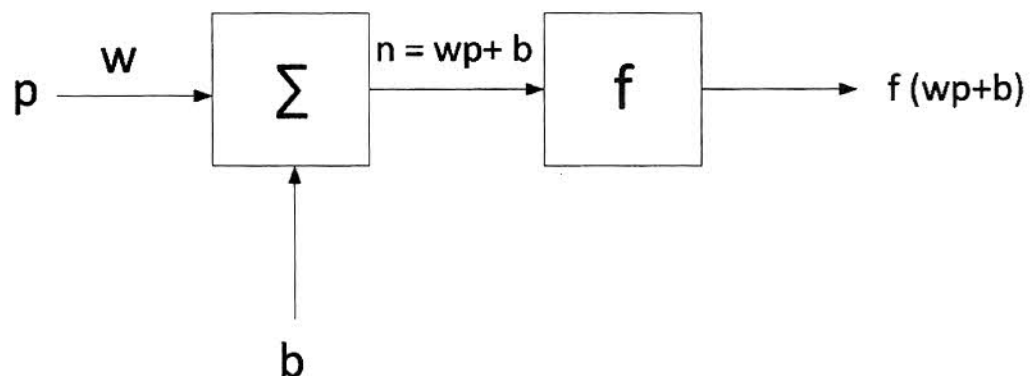

Figure 11: Single input neuron.

The elementary cells can be connected in different way to form a neural net that can be trained to do a particular job adjusting properly their weights and/or their biases (supervised learning) or letting it learn by itself (unsupervised learning that is typical of the self-organizing nets).

The transfer function of the neuron can have different expressions that are: step (symmetric and asymmetric), linear (with saturation or without saturation), sigmoidal (logarithmic or tangential), triangular, radial, and others, which are shown in Fig. 12.

If the neuron has more inputs:

$$\mathbf{P} = [p_1, p_2, \dots, p_R], \tag{1}$$

each of them is multiplied by the weights:

$$\mathbf{w} = [w_{1,1}, w_{1,2}, \dots, w_{1,R}], \tag{2}$$

and the sum unit executes the dot product  $\mathbf{w}\mathbf{p}$ , adding the bias  $b$  to give:

$$w_{1,1}p_1 + w_{1,2}p_2 + \dots + w_{1,R}p_R + b, \tag{3}$$

that is the argument of the output transfer function.

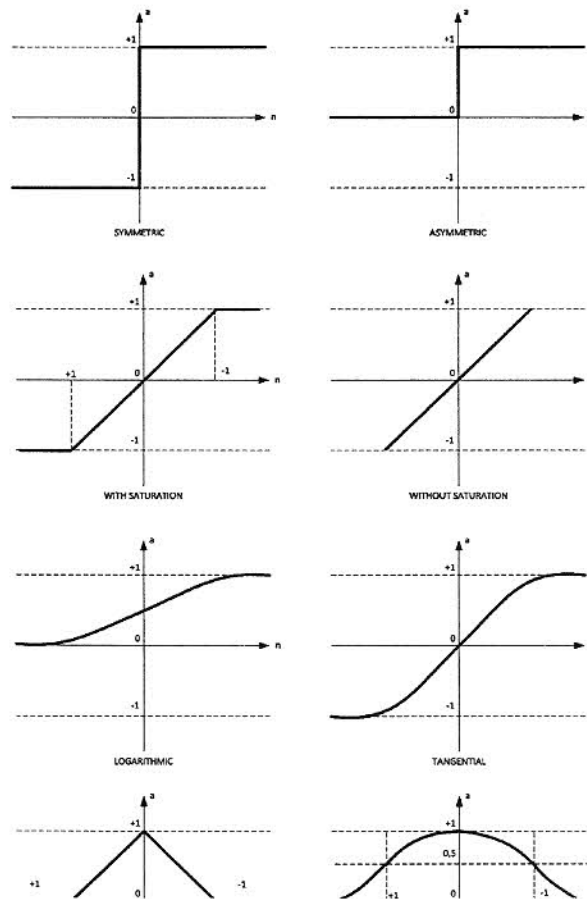

Figure 12: Example of different kind of transfer functions.

An example of multiple input neuron is shown in Fig. 13.

Two or more multiple neurons can be combined to generate a layer of neurons. Considering a layer composed by  $S$  neurons, each element of the input vector  $\mathbf{p}$ , composed by  $R$  elements, is connected to each neuron input through the weight matrix  $\mathbf{w}$ . The  $j$ th neuron weights properly its inputs, performing a dot product and adding the  $j$ th bias to generate its scalar output  $n(i)$ . The various values  $n(i)$  taken together, form a vector  $\mathbf{n}$  composed by  $S$  elements. Each element of the vector  $\mathbf{n}$  represents the input of the transfer function of the relative neuron. At the output, a column vector  $\mathbf{a}$  is obtained.

Generally the number of inputs  $R$  is different from the number of neurons  $S$ .

An example of a layer of neurons is shown in Fig. 14.

In a layer of neurons the weight matrix  $\mathbf{w}$  has the following form:

$$\mathbf{w} = \begin{bmatrix} w_{1,1} & w_{1,2} & \dots & w_{1,R} \\ w_{2,1} & w_{2,2} & \dots & \\ \dots & \dots & \dots & \dots \\ w_{S,1} & & \dots & w_{S,R} \end{bmatrix}, \quad (4)$$

where the row indices indicate the destination neuron of the weight and the column indices indicate which source is the input for that weight. For example, the weight labeled with (3, 2) expresses the strength of the signal from the second input element to the third neuron.

When we deal with a multiple layer net, we deal with different weight matrixes  $\mathbf{w}$ , different bias vectors  $\mathbf{b}$ , and different output vectors  $\mathbf{a}$  each of them referring to the relative layer.

In this situation, the first layer is called input layer, the network output is called output layer, and the intermediate layers are called hidden layers.

Multiple layers nets can perform complex functions. For example, a two-layer net, where the first layer is sigmoid and the second layer is linear, can be trained to approximate any function with a finite number of discontinuities.

Networks with biases are able to represent relationships between inputs and outputs easier than networks without biases. In fact, a neuron without a bias will always have a net input to

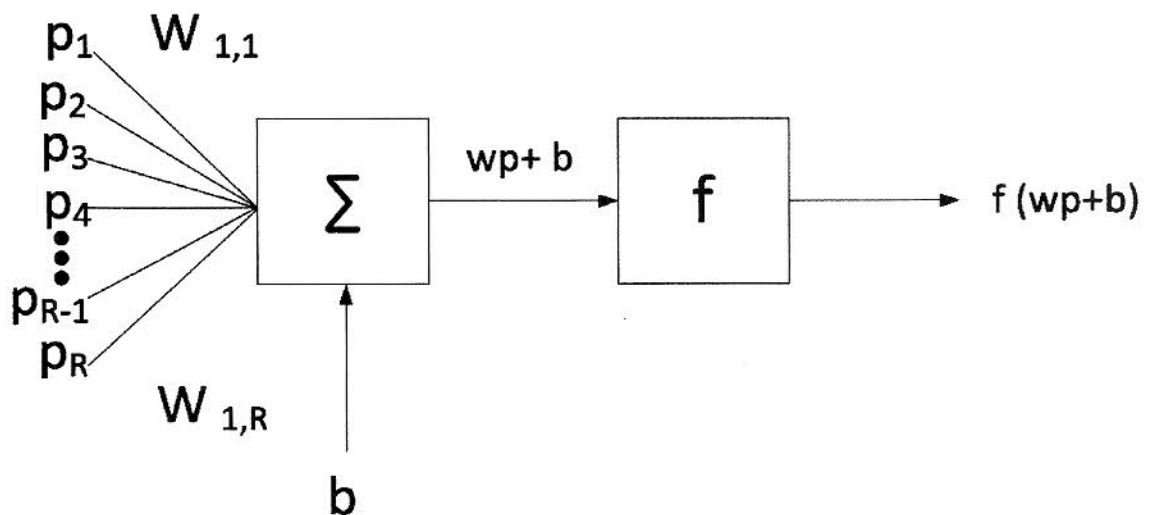

Figure 13: Multiple input neuron.

